

# VAF

INSTRUMENTS



## MidFlow<sup>®</sup> / HiFlow<sup>®</sup>

Sliding Vane Meters DN 25-300 (1"-12")

# 127

Product Bulletin

[WWW.VAF.NL](http://WWW.VAF.NL)

**TO BE  
REALLY  
SURE**

# Introduction

VAF Instruments MidFlow®/HiFlow® positive displacement type liquid flowmeters are used in continuous metering applications, in-line blending processes and batch applications. MidFlow®/HiFlow® flowmeters have a simple, rugged design. With only few almost frictionless moving internal parts there is hardly any wear in the flowmeter which safeguards a typical long lasting lifetime. MidFlow®/HiFlow® meters have no mechanical seals saving you from regular maintenance and possible leakage of process liquids into the environment. The flowmeter is driven by the process liquid which makes it suitable for distant locations without power supply. The high accuracy of the flowmeter (better than 0.1% and repeatability 0.05%) is not influenced by process pressure or temperature, mechanical pipe strain or liquid turbulence and therefore straight inlet and outlet pipe pieces are not required.

## Experience in flow measurement

In 1938 VAF Instruments started as a manufacturer of petrol delivery pumps. The flowmeters made by VAF for this pump already had to have the highest accuracy and had to meet the demands of the board of weights and measures. Innovation and research over the past 70 years helped VAF to make new types of flowmeters bearing in mind customer requirements and the need for accurate flow measurement. VAF Instruments flowmeters are available in sizes from 8 mm up to 300 mm (1 l/hr up to 960 m<sup>3</sup>/hr). MidFlow®/HiFlow® flowmeters cover the middle and high part of this range.

## Available MidFlow®/HiFlow® meters

MidFlow®/HiFlow® flowmeters are available in connection sizes from 25 mm up to 300 mm representing maximum flow ranges from 160 l/min up to 16000 l/min. A choice of material is available with ductile iron, steel and stainless steel. For registration of the measured amount of liquid, VAF MidFlow®/HiFlow® meters can be fitted with various combinations of counters and pulse transmitters.

## Liquids

VAF positive displacement flowmeters series MidFlow®/HiFlow® are suitable for a wide range of liquids. Because liquids with higher viscosities do not degrade the accuracy of the sliding vane flowmeter, it is possible to use only one flowmeter for various liquids. MidFlow®/HiFlow® meters are used for acids, alkalines, cleansing liquids, solvents, water, edible oils and fats, liquor, glucose, paint, all petrochemical liquids from LPG to bitumen, alcohol, printing ink, glue and many other organic and inorganic liquids.

## Special versions

This brochure comprises only VAF Instruments' standard delivery program. Special flowmeter variants can be offered as tailor-made solutions. Consult VAF Instruments for further information. MidFlow®/HiFlow® are registered trade marks of VAF Instruments B.V.

# Principle of operation

VAF Instruments positive displacement flowmeters operate on the sliding vane principle. The meter consists of a specially shaped housing in which a rotor can rotate freely.

Two pairs of vanes are placed into four slots in the rotor. Each pair is positioned by a rod and can move in and out of the rotor. The radial movement of the vanes is guided by the special inner shape of the housing. This patented construction provides a constant seal between the inlet and the outlet of the meter. The incoming liquid forces the rotor to rotate. The rotation of the rotor is transferred via a magnetic coupling to a read out device. This can be a counter in any desired engineering unit or a pulse transmitter for remote read out, flow data processing or connection to a process computer.

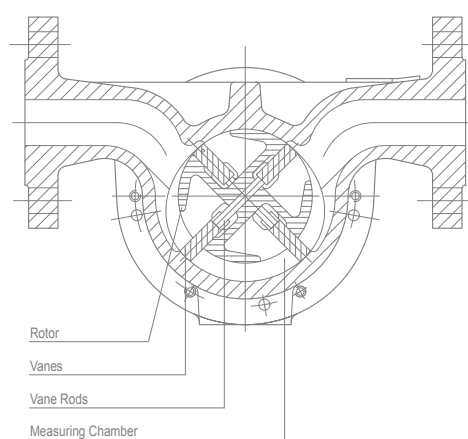

Fig. 1 Sectional view

# Features & benefits

Features	Benefits
High capacity and rangeability	One meter for a wide range of flows
	Lower investment
High accuracy	Exact registration of transferred amount of liquid
	No loss of valuable raw material
Design simplicity	Easy to service
	No complex replacement parts
	Low operation cost
Accuracy not degraded by: process pressure / process temperature / liquid viscosity / liquid conductivity / pipe strain / flow pattern (turbulence)	Easy to operate because no need for external settings saving time in operation and training
	One single meter model is suitable for different liquids resulting in a lower investment
	No straight pipe required before or behind meter thus less space required
Compact design	Easy to integrate in compact systems
	Space saving
Certified by European Classification Authorities (MID - approval) for custody transfer applications	Calibration according standard procedures
Constructed to CE standards	Time saving
From ISO 9001 registered company	No special adjustments necessary
Few internal parts	Assured product quality
	Less wear
	Long lifetime
Measurement driven by liquid	Low operation cost
	No auxiliary power needed
	Suitable for many remote locations
Local and/or remote registration with standard counters and Ex pulse transmitters	Standard flowmeter suitable for hazardous areas



Fig. 2 MidFlow® meter

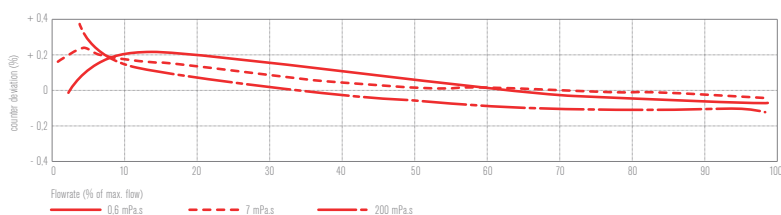

Fig. 3 MidFlow® meter

# Technical specification

## Typical calibration curves

VAF Instruments flowmeters perform liquid measurement with the highest accuracy. This graph shows typical calibration curves for liquids with different viscosities. Consult the factory for other values.



## MidFlow®

Basic model number	J5025	J5040	J5050	J5080	J5100	J1025	J1040	J1050	J1080	J1100	J3025	J3040	J3050	J3080	J3100			
Connection size, DN [mm]	25	40	50	80	100	25	40	50	80	100	25	40	50	80	100			
Capacity [l/min]	see graphs																	
Maximum, 8 hrs/day discontinuous	160	250	500	1900	2750	160	250	500	1900	2750	160	250	500	1900	2750			
Maximum, continuous	120	190	380	1450	2000	120	190	380	1450	2000	120	190	380	1450	2000			
Minimum, range 1:10	16	25	50	190	275	16	25	50	190	275	16	25	50	190	275			
Minimum, range 1:20	8	12,5	25	80	137,50	8	12,5	25	80	137,50	8	12,5	25	80	137,50			
Displaced volume per revolution [litre]	0,167	0,167	0,40	2,95	5,30	0,167	0,167	0,40	2,95	5,30	0,167	0,167	0,40	2,95	5,30			
Measuring accuracy																		
range 1:10 <sup>1</sup>	± 0,2 %			± 0,1 %			± 0,2 %			± 0,1 %			± 0,2 %			± 0,1 %		
range 1:20 <sup>2</sup>	± 0,3 %			± 0,3 %			± 0,3 %			± 0,3 %			± 0,3 %			± 0,3 %		
Repeatability	better than ± 0.05 %																	
Required starting pressure [kPa (bar)]	3 (0,03)																	
Materials																		
body	ductile iron					AISI 316												
rotor	ductile iron			cast iron		ductile iron			cast iron		AISI 316							
covers	ductile iron / steel on application					steel												
vanes	carbon																	
o-rings	vitron A / PFA covered Vitron A or Kalrez on application										PFA covered vitron A / kalrez on application							
bearings	steel ball bearings / stainless steel ball bearings on application										AISI 316 needle bearings							
Body pressure rating [kPa (bar)]	2000 (20)			1050 (10,5)		2500 (25)			2000 (20)		2500 (25)			2000 (20)				
with steel covers	2500 (25)		2000 (20)			not applicable												
Available flanges																		
DIN PN [bar]	PN 10, 16, 25; raised face or with groove acc. DIN 2512N																	
ANSI	150, 300 RF <sup>3</sup>																	
JIS [K]	5, 10, 16, 20																	
Liquid temperature range standard	-15 °C to 120 °C for temperatures above 120 °C consult factory																	
Weight without counter [Kg]	13	16	24	78	108	13	16	24	78	108	13	16	24	78	108			

Notes: <sup>1</sup> standard factory calibration. <sup>2</sup> calibration on request. <sup>3</sup> for 300 lbs flanges on 100 mm models consult factory.

### Flow ranges

To select the appropriate meter size for your process the graphs must be used. The data in these graphs only refer to standard flowmeters used on Newtonian liquids. Consult VAF Instruments for viscosities higher than shown in the graphs. Lower minimum capacities are possible dependent on liquid viscosity and required measuring accuracy.

### Flowrate - pressure drop viscosity relation

These graphs show the pressure drop across the flowmeter as a function of the flowrate and the viscosity of the liquid. The sloping lines are lines of equal viscosity. The curve at the top of the graphs represents the maximum allowable pressure drop.

## HiFlow®

Basic model number	J5150	J5200	J5250	J5300	J1150	J1200	J3150	J3200
Connection size, DN <sup>1</sup> [mm]	150	200	250	300	150	200	150	200
Capacity [l/min]	see graphs							
Maximum, 8 hrs/day discontinuous	4.600	8.000	12.500	16.000	4.600	8.000	4.600	8.000
Maximum, continuous	3.450	6.000	9.500	12.000	3.450	6.000	3.450	6.000
Minimum, range 1:10 <sup>2</sup>	460	800	1.250	1.600	460	800	460	800
Minimum, range 1:20 <sup>3</sup>	230	400	625	800	230	400	230	400
Displaced volume per revolution [litre]	11,9	29,3	58,6		11,9	29,3	11,9	29,3
Measuring accuracy								
range 1:10	± 0,1 %							
range 1:20	± 0,3 %							
Repeatability	better than ± 0,05 %							
Required starting pressure [kPa (bar)]	3 (0,03)							
Materials								
Body	ductile iron				AISI 316			
Rotor	cast iron						AISI 316	
Covers	ductile iron				carbon steel		AISI 316	
Vanes	carbon							
O-rings	Viton A, PFA covered Viton A						PFA covered Viton A	
Bearings	steel						stainless steel	
Body pressure rating, [kPa (bar)]	1050 (10,5)	1250 (12,5)	1250 (12,5)	1250 (12,5)	1600 (16)	1600 (16)	1600 (16)	1600 (16)
Available flanges								
DIN PN [bar]	10, 16; optional with groove acc. DIN 2512N							
ANSI	150 RF							
JIS [K]	5,10							
Liquid temperature range standard	-15°C to 120°C							
Weight without counter [Kg]	215	585	1000	1100	230	605	320	500

Notes: <sup>1</sup> Model no. J5300 can also be supplied with DN 350 and 400 (14" and 16") flanges. Consult factory on applications.

<sup>2</sup> Standard factory calibration. <sup>3</sup> Calibration on request.

# Technical specification

## Note

For liquids with viscosities below 0.5 mPa.s and/or with poor lubricating properties it is also advisable to reduce the maximum flow, or to use the flowmeter not continuously, as in batching applications, to prevent excessive wear of the vanes. A general rule is to reduce the maximum capacity to 75%

of the value specified in the table. Lower minimum capacities are possible dependent on liquid viscosity and required measuring accuracy.

Consult VAF Instruments on application.

Note: 1 cSt = 1 mPa.s if specific gravity is 1.0

## MidFlow®

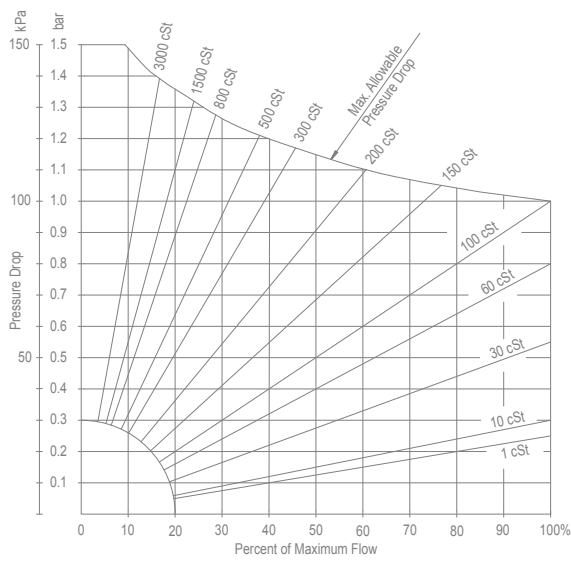

Meter size DN 25 mm: 100% = 160 l/min

Meter size DN 40 mm: 100% = 250 l/min

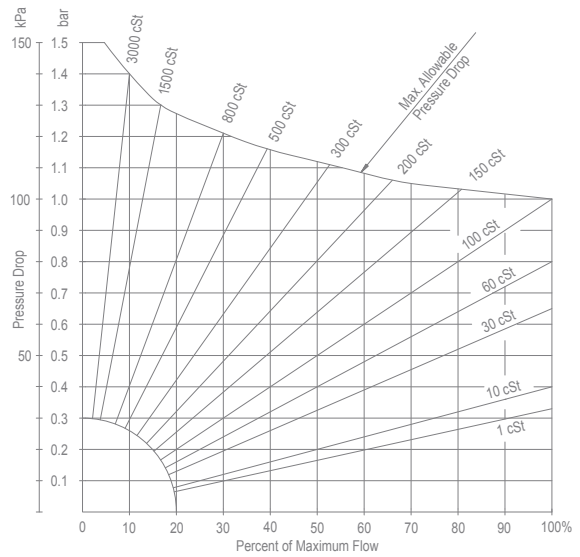

Meter size DN 50 mm: 100% = 500 l/min

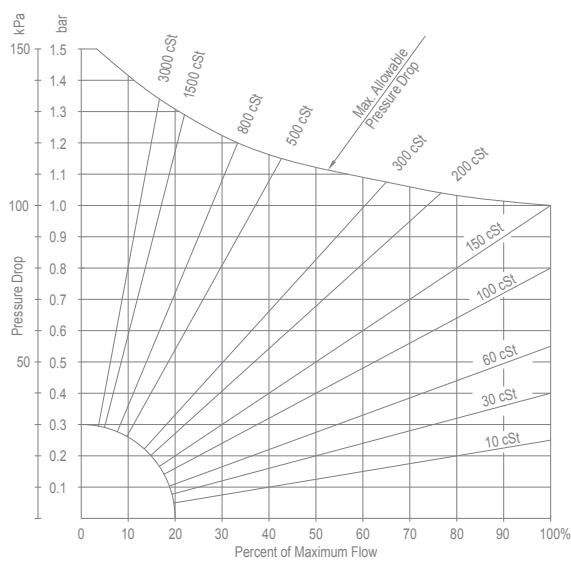

Meter size DN 80 mm: 100% = 1900 l/min

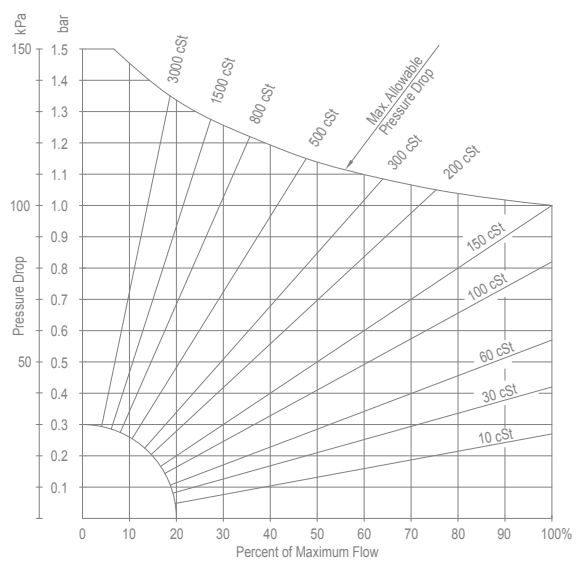

Meter size DN 100 mm: 100% = 2750 l/min

# HiFlow®

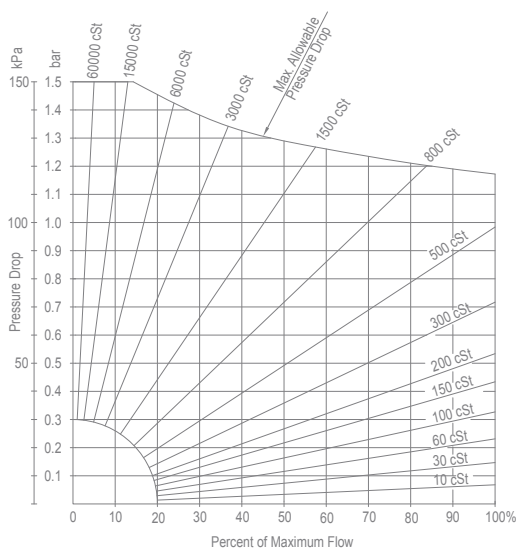

Meter size DN 150 mm: 100% = 4600 l/min

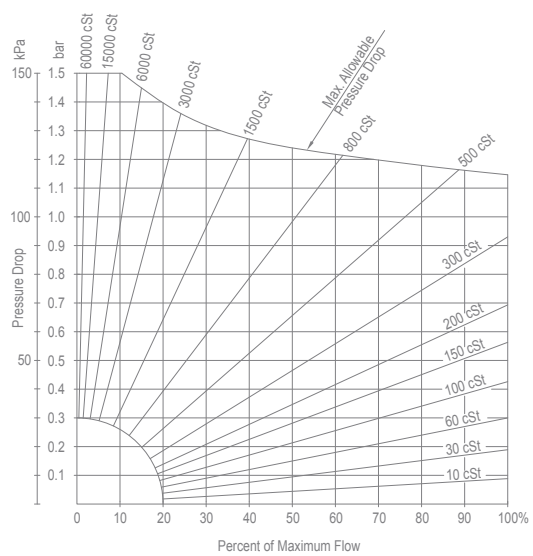

Meter size DN 200 mm: 100% = 8000 l/min

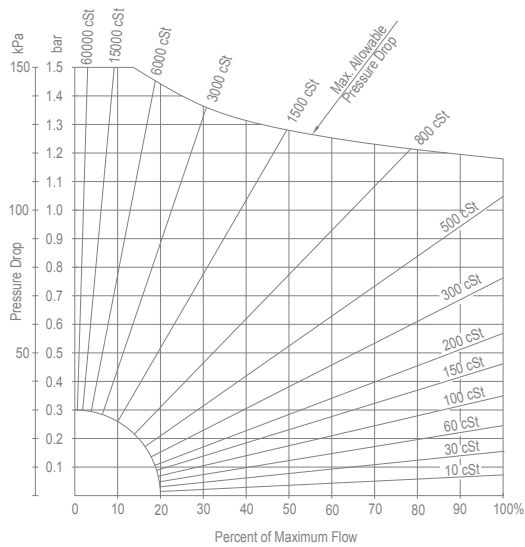

Meter size DN 250 mm: 100% = 12500 l/min

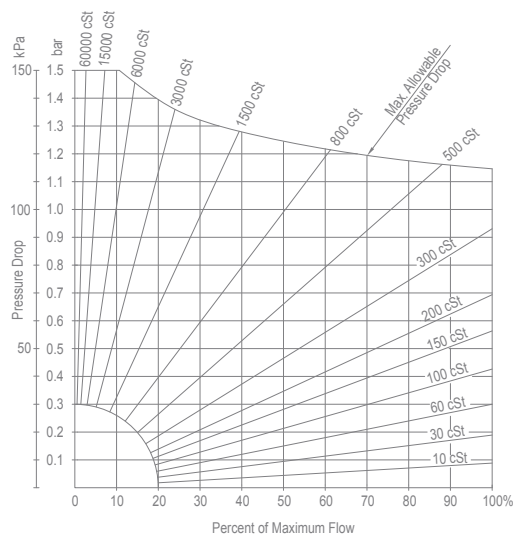

Meter size DN 300 mm: 100% = 16000 l/min

# Options & accessories

## Counters, pulse transmitters and accessories

VAF MidFlow®/HiFlow® meters can be fitted with various combinations of counters and pulse transmitters. All can be calibrated to read in litres, cubic meters or gallons. The following meter mounted counters and pulse transmitters are available:



Key resettable totaliser for simple totalising jobs. Direction of reading from the top of the flowmeter. An inductive pulse transmitter can be installed in the counter adapter as optional extra.



FlowCount rate totaliser. Fully programmable battery or loop powered LCD counter. Displays rate and accumulative and resettable totals. Optional with 4-20 mA output or flow alarm.



Resettable flowmeter register for registering delivered or transferred quantities per job and in total. Optionally available with extension between meter body and counter. Combinations with pulse transmitters are possible.



Mechanical batch counter. Mechanical, electrical or pneumatic 2-stage knock-off. Optionally available with extension between meter body and counter. Combinations with pulse transmitters are possible.



Ticket printer. Records and prints liquid deliveries and transactions. For use with reset and preset counters. Accumulative or zero start models available.



Flowrate/mass flowrate indicator for local read-out of litres/minute, kg/hour, % of maximum flowrate, or other engineering units. An inductive pulse transmitter can be installed as optional extra.



Pulse transmitters for remote flow monitoring and control. Pulse generators used are inductive proximity switches acc. NAMUR DIN 19234 or incremental pulse encoders fitted to the resettable flowmeter register.

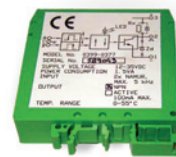

Pulse discriminator (din rail mounting) to prevent pulse signal errors caused by pipeline vibrations and flow pulsations, or where other unsteady flow conditions would prevent smooth rotation of the meter. For use with 2 inductive pulse transmitters.



### General

- Liquid filter/Airvent;
- Appropriate liquid filtering is essential for protection of the flowmeter;
- Cooling rings for protection of the counting mechanism against operating temperatures above 120°C;
- Bi-directional flow (50% return flow);
- Material certificate acc. EN 10204 3.1;
- Custody transfer accuracy certification;
- Special adaptations for accurate measurement of liquids with very high or very low viscosity's, e.g. molasses or LPG;
- Helium leak-test when volatile liquids must be measured;
- Heating covers;
- Counter extension between counter and meter body for easier reading on loading platforms etc. Extension length up to 3 metres;
- Automatic temperature compensation;
- Internal flushing bores. Prevent deposits when crystallising liquids must be measured;
- Stainless steel encapsuled magnet coupling between meter body and counter adapter. Prevents corrosion by aggressive process liquids.

### Electronic signal processing instrumentation

VAF Instruments offers a complete range of microprocessor controlled, analogue and digital instruments for indicating, totalising, registering and controlling liquid flows. Electronic instruments are available as modular plug-in units or in housings for wall or flush panel mounting. Output options for a number of instruments provide interfaces to chart recorders, printers, alarms and distributed control networks. VAF's engineers will be pleased to assist you in working out customized flow control systems in accordance with your requirements. At the present time our basic series of electronic flow signal processing instrumentation comprises:

- Flow computers;
- Multifunction flow controllers;
- Flow totalisers with optional temperature compensation;
- Batch counters;
- Batch controllers;
- Ratio controllers;
- Pulse amplifiers/pulse discriminators;
- Power supplies;
- Scalers;
- Frequency-to-current converters.



## Applications

Some of the many applications are:

- Fuel consumption measurement of combustion engines and oil burners;
- Blending of additives in the process industry;
- Fuel oil bunkering and blending;
- Addition of catalysts to chemical reactors;
- Dyeing yarn, leather, plastics, etc.;
- Coating of sheet materials;
- Injection of oils and fats in the foodstuffs and animal feed industries;
- Flow control of dosing pumps;
- Dosing of additives in cement concrete preparation;
- Measurement of liquid movement in hydraulic systems;
- Accurate measurement of viscous liquids at low flowrates;
- Dosing of liquids in the paint, tobacco and beverage industries.



# Dimensions

All dimensions apply to flowmeters with DIN PN 10/16/25 flanges.

Dimensions of flowmeters with other pressure rating are available on application.

All dimensions are in millimetres.

## MidFlow®

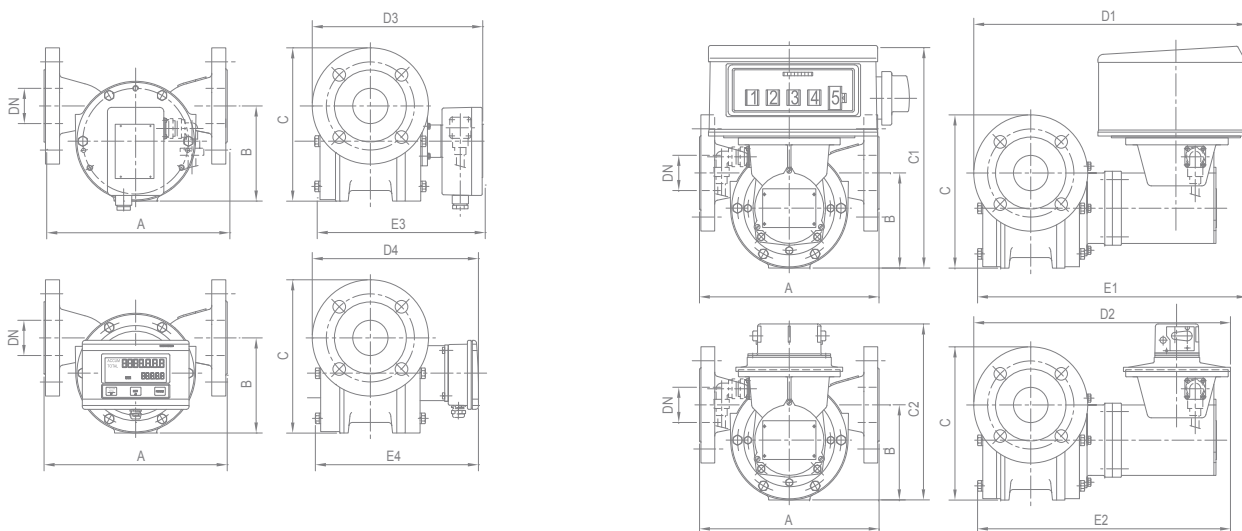

Basic model number	J1025	J5025	J3025	J1040	J5040	J3040	J1050	J5050	J3050	J1080	J5080	J3080	J1100	J5100	J3100
Connection size	DN 25			DN 40			DN 50			DN 80			DN 100		
A	240			240			260			400			450		
B	110			110			135			243			285		
C	168			185			218			343	345	343	395	397	395
C1	300			300			315			373			400		
D1	350		354	368		372	397	395	403	477	470	494	511	504	550
E1	348		365	348		365	393	389	413	520	502	563	570	552	638
C2	235			235			250			308			335		
D2	326		330	343		347	372	370	378	452	445	469	487	480	526
E2	324		340	324		340	369	365	389	496	478	538	546	528	613
D3	240		244	258		262	287	285	293	367	360	384	401	394	440
E3	238		255	238		255	283	279	303	410	392	453	460	442	528
D4	217		221	235		239	264	262	270	344	337	361	378	371	417
E4	215		232	215		232	260	256	280	387	369	430	437	419	505

# Dimensions

Flange dimensions apply to flowmeters with DIN PN 10 flanges.

Dimensions of flowmeters with other pressure ratings are available on application.

All dimensions are in millimeters.

## HiFlow®

Dimensions of model no. JZ150 and JZ200

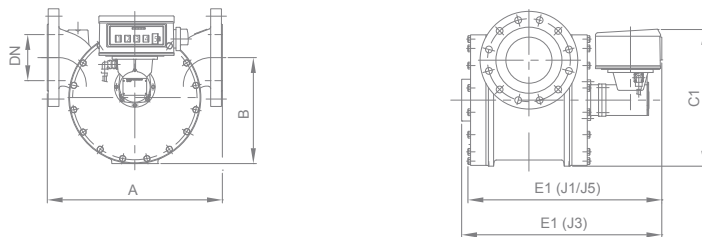

Dimensions of model no. J5250 and J5300

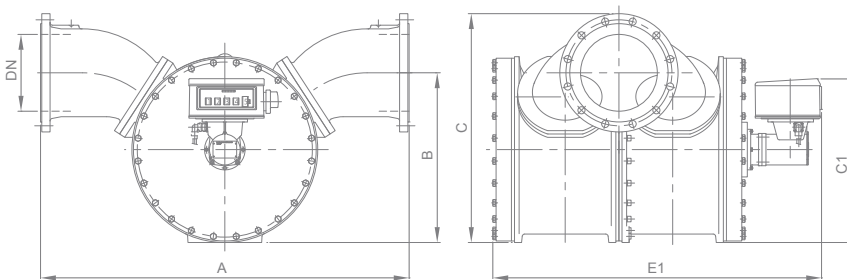

Basic model number	J5150	J5200	J5250	J5300
Connection size	DN 150	DN 200	DN 250	DN 300
A	550	900	1200	1200
B	345	528	553	578
C	283	343	395	445
D	23	22	22	22
E	241	295	350	400
F	215	268	320	370
G	130	225	250	275
H	180	225	400	400
I	360	450	800	800
J	423	440	633	633
K	321	366	559	599
L (min.)	26	29	31	33
M	3	3	3	4

### Quotation & ordering information

For proper selection of the suitable MidFlow®/HiFlow® meter the following data should be determined:

#### Liquid data:

1. **Process liquid** (trade name or chemical composition): \_\_\_\_\_
2. **Flowrate** [l/min] minimum: \_\_\_\_\_ continuous: \_\_\_\_\_ maximum: \_\_\_\_\_
3. **Operating pressure range** [bar]: \_\_\_\_\_ allowable pressure drop (bar): \_\_\_\_\_
4. **Operating temperature range** [°C] process liquid: \_\_\_\_\_ ambient: \_\_\_\_\_
5. **Specific gravity at operating conditions:** \_\_\_\_\_ viscosity: \_\_\_\_\_

#### Flowmeter data:

6. **Basic model number:** \_\_\_\_\_
7. **Diameter liquid piping:** \_\_\_\_\_
8. **Wetted parts material:**  ductile iron  carbon steel  AISI 316
9. **Connection flanges:**  DIN PN [bar]: \_\_\_\_\_  ANSI RF [lbs]: \_\_\_\_\_  JIS [K]: \_\_\_\_\_
10. **Direction to flow:**  left to right  right to left  top to bottom  bottom to top
11. **Local counter:**  no built-on counter (continue with step 12)  
 key-resetable totaliser  
 resetable flowmeter register  
     mechanical batch counter:  electrical  pneumatic  
     knock-off:  1 stage knock-off  2 stage knock-off  
 ticket printer (on resetable flowmeter register or mechanical batch counter)  
 flowrate indicator  
 flowcount rate totaliser
12. **Pulse Transmitter:**  number of low speed inductive pulse transmitter(s): \_\_\_\_\_ ; preferred pulses/litre:  
 number of high speed inductive pulse transmitter(s): \_\_\_\_\_ ; preferred pulses/litre:  
 pulse discriminator, (din rail mounting) using 2 inductive pulse transmitters  
 incremental pulse encoder
13. **Liquid filter:**  required  not required
14. **Special certification:**  inspection by customer  standard factory calibration  
 inspection by classification authority:  
 factory test and material certificate acc. EN 10204 3.1  
 MID  other: \_\_\_\_\_
15. **Tagging:**  paper tag  stn. stl. tag fixed to flowmeter
16. **Other options & accessories:** \_\_\_\_\_

Name: \_\_\_\_\_

Place and date: \_\_\_\_\_

For further information see relevant Product Bulletins or [www.vaf.nl](http://www.vaf.nl)

Represented by

#### VAF Instruments B.V.

Vierlinghstraat 24, 3316 EL Dordrecht, The Netherlands

P.O. Box 40, 3300 AA Dordrecht, The Netherlands

T +31 (0) 78 618 3100, F +31 (0) 78 617 7068

[sales@vaf.nl](mailto:sales@vaf.nl), [www.vaf.nl](http://www.vaf.nl)

Specifications subject to change without notice.

Agents and distributors in more than 50 countries.

