

VAF

INSTRUMENTS



LoFlow[®]

Series M Milliflow[®] Piston Meters DN 8-12 mm

110

Product Bulletin

WWW.VAF.NL

TO BE
REALLY
SURE

Introduction

VAF Instruments LoFlow® piston flowmeters, operating on the positive displacement principle, are used in continuous metering applications, in-line blending processes and batch applications. The accuracy of the Milliflow® meter is better than 0,5% and the repeatability is 0,05%.

Experience in flow measurement

In 1938 VAF Instruments started as a manufacturer of petrol delivery pumps. The flowmeters made by VAF Instruments for this pump already had to have the highest accuracy and had to meet the demands of the board of weights and measures. Innovation and research over the past 70 years helped VAF to make new types of flowmeters bearing in mind customer requirements and the need for accurate flow measurement. VAF Instruments flowmeters are available in sizes from 8 mm up to 300 mm (1 l/hr up to 960 m³/hr). LoFlow® flowmeters cover the lower part of the range.

Available LoFlow® Milliflow® meter

Milliflow® meter are available in connection sizes from 8 mm up to 12 mm representing maximum flow ranges from 1 l/hr up to 200 l/hr. For registration of the measured amount of liquid VAF LoFlow® meters can be fitted with various combinations of counters and pulse transmitters.

Liquids

VAF Milliflow® meter are suitable for a wide range of liquids; acids, alkalines, cleansing liquids, solvents, water, edible oils and fats, liquor, glucose, paint, all kind of petrochemical liquids, alcohol, printing ink, glue and many other organic and inorganic liquids.

Special versions

This brochure comprises only VAF Instruments' standard delivery program. Special flowmeter variants can be offered as tailor-made solutions.

Consult VAF Instruments for further information.

LoFlow® and Milliflow® are registered trade marks of VAF Instruments B.V.

Principle of operation

Operating on the positive displacement principle the flowmeter consists of four radial pistons, actuated in turn by the head pressure of the liquid. The pistons are linked to a crankshaft which is connected by a magnetic coupling to an LCD type rate-totaliser or to a mechanical totaliser with or without electric pulse transmitter.

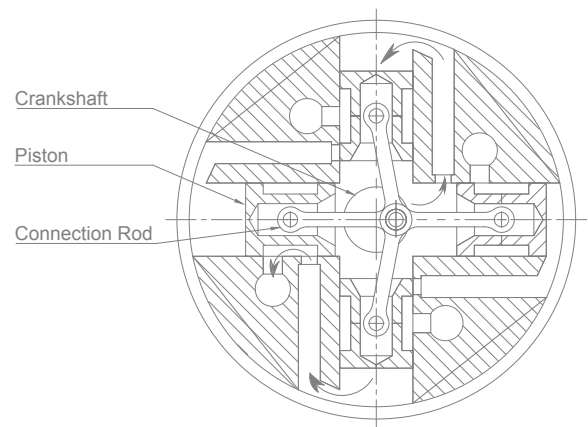

Fig. 1 Sectional view of piston meter

Features & benefits

Features	Benefits
Designed for rough industrial environments as well as for laboratory use	Blending and batching system accuracy Saves on raw materials. Consistent end-product quality
Dependable micro-precision piston operation	Handles wide variety of liquids
Measuring accuracy better than +/- 0.5% of rate	Easy to install and operate
Handles viscosities up to 500 mPa.s (consult factory for higher viscosities)	A full line of display and signal processing instrumentation, including flow computers, available from one supplier
Local totaliser and/or pulse transmitters according NAMUR for data processing	
Pressure ratings up to 100 bar	

Technical specification

Connections	M31	M32
Pipe couplings	8 mm, 12 mm	12 mm
Male thread NPT	1/4"	3/8"
Flanges	DIN DN 15 and DN 25 / PN 10/16/25 / 1/2 " and 1 " ANSI class 150 or 300 RF (other flanges consult factory)	
Materials		
Body	AISI 316	
Bearings	Rulon, AISI 316	
Packing	Gylon (Teflon compound)	
Seal ring	PTFE, AISI 316	
Cylinder linings	Carbon, ferralium	
Temperature	Liquid: -15 to 75°C / Ambient: -15 to 55°C	
Body pressure rating [kPa (bar)]	2.500 (25), 3.500 (35), 10.000 (100)	
Counter reading		
Red pointer	0,01 litre	0,1 litre
Counter	0,1 litre	1 litre
Minimum starting pressure [kPa (bar)]	5 (0,05)	
Accuracy at 2 mPa.s	Better than $\pm 0,5$ % of rate	
Reproductability	$\pm 0,05$ %	
Viscosity	Up to 500 mPa.s is standard	
Mounting	In horizontal process piping with counter on top. Wall mounting bracket optional on models with pressure rating to PN 35 bar	
Flow direction	Left-to-right is standard. For right-to-left the counter or pulse transmitter box can be turned 180 degrees	
Liquid filter	Particles larger than 0.05 mm must be filtered out by installing a suitable filter at the inlet of the flowmeter	
Pulse transmitters		
Inductive type	1 or 2 passive proximity switches according DIN 19234 (NAMUR). Protection class IP55, intrinsically safe according PTB No. 99 ATEX 2219X and Cenelec EEx ia/ib IIC T6, if used with a suitable safety barrier	
Incremental type	Includes pulse discriminator. Supply voltage 12 - 35 VDC. Max. frequency 5 kHz	

Technical specification

Flow range and pulse range

N = number of pulses per revolution of the crankshaft

Flowmeters with inductive pulse transmitter in totaliser

Meter model no.	Connections mm [inches]	Flow range [litres/h]	Pulse rate [pulses/ml]					
			N = 1	N = 2	N = 5	N = 10	N = 20	N = 25
M31	DN 8 (1/4")	1-20	0,01; 0,5	1	2,5	0,1; 5	10	12,5
M32	DN 12 (3/8")	10-200	0,001; 0,05	0,1	0,25	0,01; 0,5	1	1,25

Non-indicating flowmeters with inductive pulse transmitter in pulse box

Meter model no.	Connections mm [inches]	Flow range [litres/h]	Pulse rate [pulses/ml]						
			N = 1	N = 2	N = 5	N = 10	N = 20	N = 25	N = 50
M31	DN 8 (1/4")	1-20	0,5	1	2,5	5	10	12,5	25
M32	DN 12 (3/8")	10-200	0,05	0,1	0,25	0,5	1	1,25	2,5

Non-indicating flowmeters with incremental pulse transmitter in pulse box

Meter model no.	Connections mm [inches]	Flow range [litres/h]	Pulse rate [pulses/ml]		
			N = 100	N = 250	N = 500
M31	DN 8 (1/4")	1-20	50	125	250
M32	DN 12 (3/8")	10-200	5	12,5	25

Typical accuracy

Limits in red area are guaranteed by factory calibration.

Within a narrower measuring range the accuracy will be better.

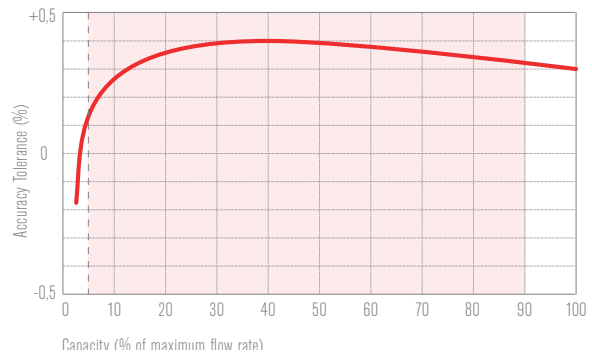

Pressure drop

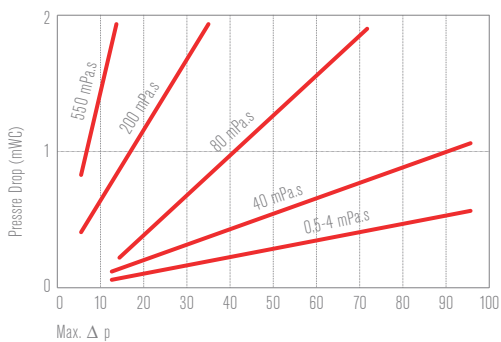

Capacity Model No. M31 (100% = 20 l/h)

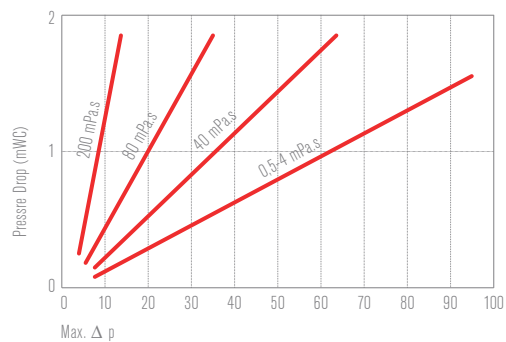

Capacity Model No. M32 (100% = 20 l/h)

Options & accessories

Available models

- a. Milliflow® meter with mechanical totaliser and optional inductive pulse transmitter;
- b. Milliflow® meter with FlowCount Rate Totaliser;
- c. Non-indicating Milliflow® meter with pulse transmitterbox.

Transmitter variants

- Inductive pulse transmitter with optional pulse discriminator;
1 or 2 passive proximity switches acc. NAMUR DIN 19234;
Protection class IP55;
Intrinsically safe acc. PTB No. 99 ATEX 2219X and Cenelec EEx ia/ib IIC T6,
if used with a suitable safety barrier;
- Incremental pulse encoder, comprising of a double pulse generator and a pulse discriminator. Open collector or active pulse output.

Pulse discriminator

The pulse discriminator prevents measuring errors caused by pipeline vibrations and unsteady flow conditions. By using two pulse transmitters in the flowmeter, generating two identical pulse trains with a signal phase shift of 90 degrees, it is possible to eliminate these measuring errors. The pulse discriminator comprises a printed circuit board installed in the pulse transmitter box. The discriminator is standard with incremental pulse encoders and is recommended for use with inductive pulse transmitters.



Fig. 2 Totaliser

Built-on Totaliser, FlowCount Rate Totaliser & Pulse Box

Series 'M' LoFlow® Milliflow® meter can be equipped with a built-on totaliser, a FlowCount rate totaliser or a pulse box. See tables for counter reading units and combinations of totaliser and pulse transmitter.

The LCD type rate totaliser is battery operated and has no need for external power supply. The instrument is mounted onto the flowmeter and is housed in a dustproof and watertight enclosure according IP67 and NEMA4X standards. The FlowCount is fully programmable with user configurable K-factor, reading units, decimal point position, filter constant and timebase. Flowrate and totals can be displayed in millilitres, litres, gallons or cubic metres, per second, minute, hour or day.

Options include a two-wire 4-20 mA output. When this option is installed, all operating power for the rate totaliser is drawn from the 4-20 mA loop, thereby extending battery life. A second option combines a DC power input with high and low flow alarms. The milliampere option and the flow alarm option can not be combined in one instrument.

A pulse transmitter box is a non-indicating box which is built directly onto the flowmeter, and holds the inductive transmitter(s) according to Namur with optional pulse discriminator, or the incremental pulse encoder that includes a discriminator.



Fig. 3 FlowCount



Fig. 4 Pulse box

Applications

The Milliflow® meter is widely used for flow measurement, batching and in-line blending operations in the process industry, pilot plants and laboratories, e.g.:

- Colouring fuel oil, textile, paper, leather and plastics;
- Paint regulation in automatic spray booths;
- Blending of additives with oils and fats;
- Applying corrosion inhibitor fluid to prevent oxidation of metal surfaces;
- Blending of freon with polythene;
- Dosing of additives to concrete mixers;
- Calibration of positive displacement pumps;
- Control of catalysts in chemical reactors;
- Addition of chemicals to boiler feed water;
- Accurate filling of hydraulic shock absorbers;
- Applying emulsion adhesives to audio and video tapes or photographic materials;
- And many other applications.

Dimensions

Except where noted all dimensions are in millimetres.

Dimensions of other versions not shown here are available on request.

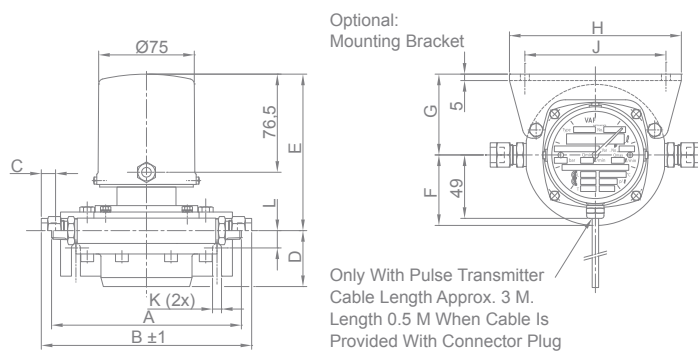

Meter model no.	Connections size						D	E	F	G	H	J	K	L	Weight max. [Kg]
	1/4"	3/8"	pipe couplings												
	NPT	NPT	8 mm		12 mm										
A	A	B	C	B	C										
M31	148	-	158	8	164	11	44	121	55	63	134	110	7	14	4
M32	-	207	-	-	226	11	76	123	85	93	190	160	10	12	11

Dimensions

Except where noted all dimensions are in millimetres.

Dimensions of other versions not shown here are available on request.

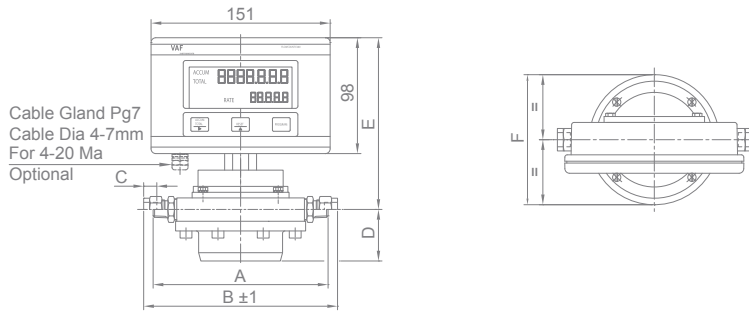

Meter model no.	Connections size						D	E	F	Weight max. [Kg]
	1/4"	3/8"	pipe couplings							
	NTP	NTP	8 mm		12 mm					
A	A	B	C	B	C					
M31	148	-	158	8	164	11	44	146	110	6
M32	-	207	-	-	226	11	76	148	170	9

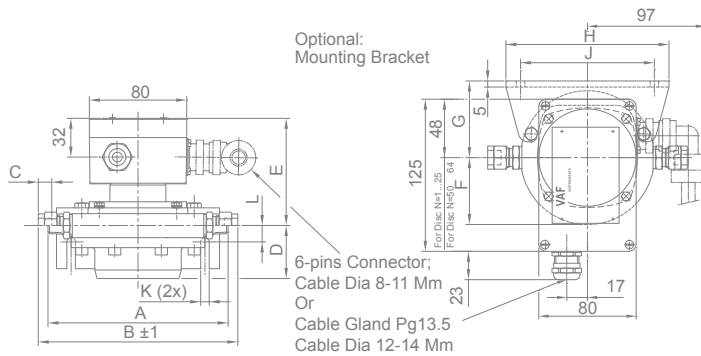

Meter model no.	Connections size						D	E	F	G	H	J	K	L	Weight max. [Kg]
	1/4"	3/8"	pipe couplings												
	NPT	NPT	8 mm		12 mm										
A	A	B	C	B	C										
M31	148	-	158	8	164	11	44	92	55	63	134	110	7	14	4
M32	-	207	-	-	226	11	76	94	85	93	190	160	10	12	11

Quotation & ordering information

For proper selection of the suitable MilliFlow® meter the following data should be determined:

Fluid data:

- Process liquid** (trade name or chemical composition):
- Flowrate** [l/h] minimum: _____ normal: _____ maximum: _____
- Operating pressure range** [bar]: _____ allowable pressure drop [bar]: _____
- Operating temperature range** [°C]: _____
- Specific gravity at operating conditions** [kg/l]: _____
- Viscosity at operating conditions** [mPas]: _____

Flowmeter data:

- Basic model no.:** M31 M32
- Connections:** threaded pipe couplings
 DIN flanges ANSI flanges
- Flange size:** DN 15 (1/2") DN 25 (1")
- Local counter:** totaliser no local counter (continue with step 11)
 totaliser with inductive pulse transmitter
no. of pulse generators: _____ no. pf pulses/ml: _____
 flowcount rate totaliser
reading unit: ml litres per minute per hour
other reading unit: _____
flowcount options: 4 - 20 mA output intrinsically safe
 other options consult factory

11. Non-indicating pulse transmitter box:

- inductive pulse transmitter no. of pulse transmitters (max. 2): _____ no. of pulses/ml: _____
pulse discriminator: required not required
- incremental pulse encoder (includes pulse discriminator) no. of pulses/ml: _____
electrical connection: 6 pin connector cable gland
output for discriminator: active pulse output open collector output

12. Options & accessories: wall-mounting bracket required (PN 25 / 35 only) not required

13. Liquid filter: required not required

14. Certification: standard factory calibration
 material certificate acc. EN 10204 3.1
 other: _____

15. Associated electronic signal processing instrumentation (please specify): _____

Name: _____

Place and date: _____

For further information see relevant Product Bulletins or www.vaf.nl

Represented by

VAF Instruments B.V.

Vierlinghstraat 24, 3316 EL Dordrecht, The Netherlands

P.O. Box 40, 3300 AA Dordrecht, The Netherlands

T +31 (0) 78 618 3100, F +31 (0) 78 617 7068

sales@vaf.nl, www.vaf.nl

Specifications subject to change without notice.

Agents and distributors in more than 50 countries.

